

# KENWOOD

UHF FM TRANSCEIVER

TH-415A

TH-415E

VHF FM TRANSCEIVER

TH-215A

TH-215E

---

INSTRUCTION MANUAL

©PRINTED IN JAPAN B50-8120-30K, M, W, T, X1TT  
89/6 5 4 3 2 1 87/12 11 10 9 8 7 6 5 4 3 2 1

Thank you for purchasing the new transceiver.  
**IMPORTANT**

Please read this instruction manual carefully before placing your transceiver in service.

This instruction Manual covers the following models:

KENWOOD TH-415A: 430/440 MHz FM transceiver with DTMF.  
KENWOOD TH-415E: 430 MHz FM transceiver with Tone.  
KENWOOD TH-415E: 430 MHz FM transceiver (U.K. version) with Tone Burst.  
KENWOOD TH-215A: 144 MHz FM transceiver with DTMF.  
KENWOOD TH-215E: 144 MHz FM transceiver with Tone.  
KENWOOD TH-215E: 144 MHz FM transceiver (U.K. version) with Tone Burst.

### SAVE THIS INSTRUCTION MANUAL.

Under normal circumstances, the transceiver will operate in accordance with these operating instructions. The transceiver was preset at the factory and should only be readjusted by a qualified technician with proper test equipment.

Attempting service or alignment without factory authorization can void the transceiver's warranty.

#### CAUTION:

Long transmission or extended operation in the 5 watt mode might cause the rear of this transceiver to get warm. Do not place the transceiver where the heat sink (rear panel) might come in contact with plastic or vinyl surfaces.

2

## CONTENTS

SPECIFICATIONS .....	3
ACCESSORIES .....	3
BATTERY PACK .....	4
Ni-Cd battery	
Recharging the battery pack	
Manganese/Alkaline batteries	
Operating time	
CONTROLS AND FUNCTIONS .....	5
OPERATION .....	10
Receive	
Transmit	
Frequency selection	
Beep tone .....	11
Repeater operation .....	12
Transmitter offsets	
Reverse function	
Tone operation	
Auto patch operations .....	13
Scan .....	14
Memory .....	15
Memory back-up battery .....	16
Priority alert channel check .....	16
Battery saver	
MAINTENANCE .....	18
In case of difficulty	
Service	
OPTIONAL ACCESSORIES .....	19
Programmable tone decoder unit TSU-4	
BLOCK DIAGRAM .....	another sheet
SCHEMATIC DIAGRAM .....	another sheet

Illustrations show the TH-215A.

# SPECIFICATIONS

		TH-118A/118E	TH-218A/218E
FREQUENCY RANGE MHz	U.S.A. Version	TH-118A 440,000 ~ 448,999	TH-218A 144,000 ~ 147,999
	Others	TH-118E 430,000 ~ 438,999	TH-218E 144,000 ~ 147,999
MODE	European and U.K. Version	TH-118E 430,000 ~ 438,999	TH-218E 144,000 ~ 145,999
		F3 (FM)	F3 (FM)
OPERATING TEMPERATURE		-30°C ~ +50°C (-4°F ~ +122°F)	
ANTENNA IMPEDANCE		80 Ω	
POWER REQUIREMENT	BATTERY PACK	6.3 V ~ 1.8 VDC (6.4 VDC nominal)	
	DC IN	7.2 V ~ 16 VDC (13.8 VDC nominal)	
DRIVE	1H TRANSMIT MODE 2.8 W (8.4 V)	Approx. 1.2 A	Approx. 1 A
	1H TRANSMIT MODE 5 W (13.8 V)	Less than 2 A	Less than 1.7 A
	Low TRANSMIT MODE	Less than 0.8 A	Less than 0.7 A
RECEIVE MODE WITH NO SIGNAL		Approx. 55 mA	Approx. 50 mA
1 BATTERY SAVER MODE (AT 1:21)		Approx. 20 mA	
DIMENSIONS	W x H x D	67 x 173 x 37 (mm)	
	(PROJECTIONS INCLUDED)	70 x 181 x 40 (mm)	
WEIGHT	With Ni-Cd battery and antenna	Approx. 500 g	Approx. 540 g
	With manganese battery and antenna	Approx. 540 g	Approx. 520 g
OUTPUT POWER	1H 13.8 VDC	5 W	
	with PB-1	2 W	2.8 W
	with PB-2, PB-4	1 W	1.5 W
	Low	Approx. 0.8 W	
MODULATION		REACTANCE	
MAXIMUM FREQUENCY DEVIATION		Less than ±8 kHz	
SPURIOUS RADIATION		Less than -60 dB	
CIRCUITRY	DOUBLE CONVERSION SUPERHETERODYNE		
	INTERMEDIATE FREQUENCY	1st IF 30.828 MHz	16.3 MHz
SENSITIVITY	12 dB SINAD	Less than 0.25 μV	Less than 0.2 μV
	12 dB SINAD	Less than 0.16 μV	Less than 0.1 μV
SELECTIVITY		Near than 12 kHz	
		Less than 24 kHz	
AUDIO OUTPUT POWER		More than 300 mW	
		(at 8 Ω load 10% distortion)	

NOTE: Circuit and ratings are subject to change without notice, due to development in technology.

# ACCESSORIES

Unpack your transceiver carefully and confirm that it is supplied with the following accessories.

- 1 Antenna ..... T90-0362-05 ..... 1 ea.
- 2 Rubber cap ..... B09-0307-04 ..... 1 ea.
- 3 Belt Hook (U.S.A. version) J29-0417-04 ..... 1 ea.
- 4 Machine Screw (U.S.A. version) ..... N35-3005-41 ..... 2 ea.
- 5 Spring washer (U.S.A. version) ..... N16-0030-41 ..... 2 ea.
- 6 Ni-Cd Battery pack (PB-2) .. W09-0361-05 ..... 1 ea.
- or
- AA Manganese/Alkaline Battery case ..... A02-0728-03 ..... 1 ea.
- 7 Battery charger (120 V) ..... W09-0315-15 ..... 1 ea. (U.S.A. version) or Battery charger (220 V) ..... W09-0317-15 ..... 1 ea. (European version) or Battery charger (240 V) ..... W09-0318-15 ..... 1 ea. (U.K. version) or Battery charger (240 V) ..... W09-0319-15 ..... 1 ea. (Oceania version)
- 8 Instruction Manual ..... B50-8120-XX ..... 1 copy
- 9 Warranty Card (U.S.A. version) ..... 1 ea.

## BATTERY PACK

Installing the battery pack at the bottom of the radio to the cover part at the top of the battery pack.  
Turn the battery pack clockwise until it clicks.  
Be sure the pack and transceiver are locked together.  
Removing  
Pressing the battery release button, turn the battery pack counterclockwise.

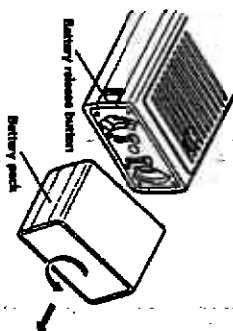

## NI-Cd BATTERY PACK (PB-2)

**NOTE:**  
This battery pack has not been charged at the factory in order to provide you with the greatest number of charge/discharge cycles. You must charge the battery before use. The battery pack will require several charge/discharge cycles before you can expect to see the maximum operating period between charges. If the battery will be stored for greater than 2 months it should be recharged before use.

## RECHARGING THE BATTERY PACK

Insert the charge plug from the BC-2 into the receptacle on the rear of the battery pack. Then plug the BC-2 into the AC line. The LED on the BC-2 will illuminate to show that the pack is charging. The LED will remain on as long as the BC-2 is connected to the AC power source and the battery, indicating that the pack is still being charged. Therefore, do not forget to unplug the charger after approximately 15 hours. **RECHARGING TIME:** Approx. 15 Hours

### NOTES:

- Turn off the power switch before charging.
- Charging should be done within an ambient temperature between 10°C - 40°C (50°F - 104°F). Charging performed out of this range may not fully charge the battery.
- If you exceed the recommended charge period, the battery performance and its life may lessen.

4

## MANGANESE or ALKALINE BATTERIES

Load SUM-3 X 6 manganese or alkaline batteries in series in the supplied battery case. (Be sure to observe the polarities.) (We recommend use of high-performance manganese batteries.) Battery pack (1) can be inserted into case (2) only in a specific direction. Check the shape (top and bottom) after moving the stopper on the rear side, then insert the battery correctly, inserting the battery by force without checking the shape may damage the case.

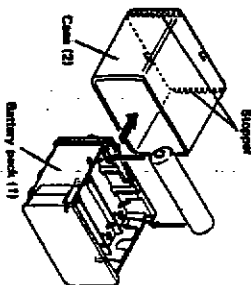

## OPERATING TIME

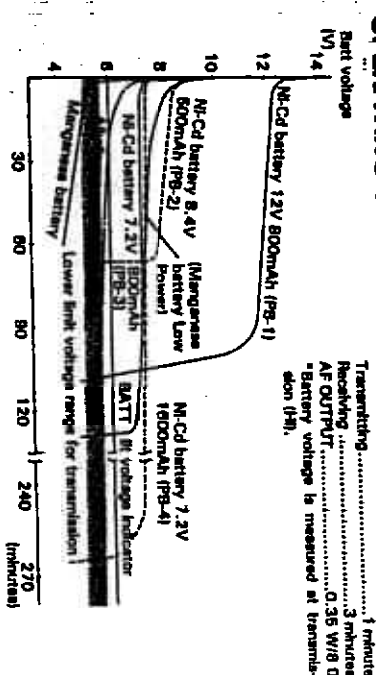

Manganese battery (except Alkaline manganese battery) is available for Low position. Recharge the Ni-Cd battery pack immediately the BATT indicator comes on. We recommend use of Ni-Cd battery pack for long transmission or extended operation.

# CONTROLS AND FUNCTIONS

**① Antenna connector**  
This jack is used to connect the supplied antenna. Twist to lock with the BNC connector.

**② DC IN terminal**  
This terminal is used for an external power supply. Input voltages is 13.8 VDC nominal. The center is the (+) side and the sleeve is (-) side.  
You should turn the power switch OFF when connecting this terminal. Pay attention to the polarity.



**CAUTION:**

As a precaution, do not remove the battery pack when an external power supply is used. Use the KENWOOD PG-2V or PG-3C optional cable for the connection.

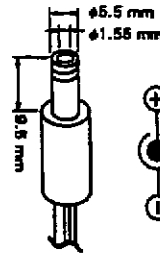

**③ MIC Jack**  
This jack is used for an external microphone of condenser type.

**④ SP Jack**  
This jack is used for an earphone or external speaker. The recommended impedance is 8 Ω nominal.

**⑤ TONE switch**  
This switch is used to activate the sub-audible tone encoder.  
European version: This switch is used to transmit a TONE signal. When the switch is pressed the repeater control signal of 1750 Hz is activated.

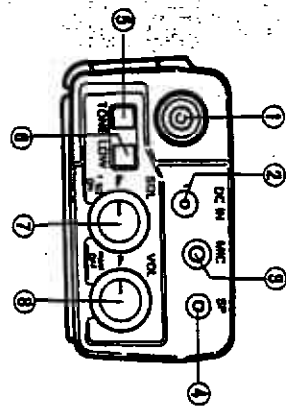

**⑥ HI ( ■ ) / LOW ( - ) switch**  
This switch is used to select the transmit output power.

**⑦ SQL control**  
The SQL control is used to eliminate noise during no signal periods. Normally, this control is adjusted clockwise until the noise just disappears and the BUSY indicator goes OFF (Threshold level). For scan operation, this control must be set to the threshold point. When an incoming signal is weak or unstable, readjust the squelch for optimum reception.  
For tone squelch operation with TSU-4, this control must be set to the T.SQ position.

**⑧ VOL control**  
Volume control with power ON/OFF switch.

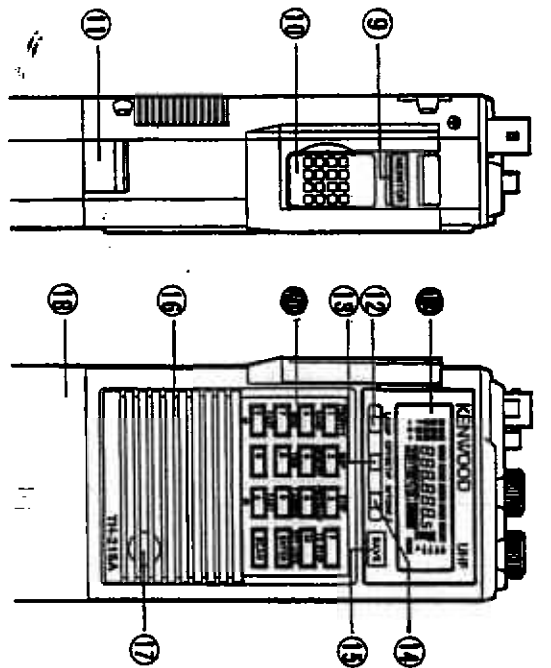

**12 LAMP key**

This key controls the lamp on the LCD display.

**NOTE:** When the LAMP is on battery drain will be accelerated. Do not use this feature unnecessarily.

**13 OFFSET/F key**

The OFFSET/F key is used to select the desired transmitter offset for repeater operation. Each time the key is pressed, the mode cycles from + shift, to - shift, to simplex, and back to + shift. When the offset function is ON, the symbol "+" or "-" is displayed.

Pressing the [F] and the OFFSET/F key in order is used to change the desired offset frequency.

**14 R/TONE, F (or REVERSE) key**

This key is used to reverse the transmit/receive frequencies during repeater operation.

**NOTE:** F: TONE FREQUENCY key (with the TH-415A/215A) Pressing the [F] and the R/TONE, F key in order is used to change the frequency of the tone encoder.

**15 SAVE key**

The SAVE key is used to select the power save condition during the receive mode.

Pressing the [F] and the SAVE key in order is used to change the battery saver circuit rate.

**16 SPEAKER**

**17 MICROPHONE**

**18 BATTERY CASE**

**9 MONITOR switch**

Pressing this key will open squelch.

**10 PTT (Push To Talk) switch**

For transmission, press this switch and speak into the microphone.

**11 RELEASE button**

Used to release the battery. Depress this button, and turn the battery counterclockwise.

## 10 Display

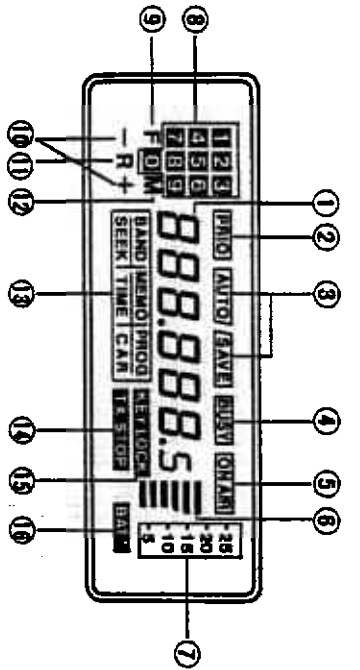

- 1** **FREQUENCY display**  
: Displays the operating frequency.
- 2** **[PRIO]**  
: ON when the Priority Alert function is active.  
Flashes when the channel is busy.
- 3** **[AUTO SAVE]**  
: Displays the selected power save condition:  
**[AUTO /SAVER]** for auto save mode,  
**[SAVE]** for save mode, and no indicator for OFF.
- 4** **[BUSY]**  
: ON whenever the squelch opens during receive.  
: ON all the time if the squelch control is rotated counterclockwise, and the T.SQ is off.
- 5** **[ON AIR]**  
: ON during transmit mode.

- 6** : Used to indicate the relative receive signal strength, or as an indication of transmitting.
- 7** : Indicates the selected frequency step.
- 8** : Indicates the selected memory channel number.
- 9** **F** : Indicates for approx. 5 seconds after pressing the **[F]** key.
- 10** **- +** : Displays the selected offset, minus or plus, and no indicator for simplex. On whenever the REVERSE function is active.
- 11** **R** : Indicates for approx. 5 seconds after pressing the **[M]** key.
- 12** **M** : Indicates the selected scan mode.
- 13** : Indicates the selected scan stop mode.  
Flashes during scan.
- 14** **[TX STOP]** : Indicates that the transmitter has been disabled by the TX.STOP key.
- 15** **[KEY LOCK]** : Indicates that all keyboard functions except LAMP key has been disabled by the KEY LOCK is activated.
- 16** **[BATT]** : ON when the battery voltage falls below the level for good communications. Recharge/replace the battery pack.

## DOUBLE ROLE KEYS

PRIORITY	BEEP	STEP	
1	2	3	F
BAND	MEMORY	PROGRAM	TX STOP
4	5	6	M
SEEK	TIME	CARRIER	KEY LOCK
7	8	9	ENTER
FAST	0	FAST	SCAN
*		#	

These 13 keys except the [F], [SCAN], and [0] keys, have two functions.

The 1st function is printed on the key.

The 2nd function is printed above the key.

All these 2nd functions are activate for approx. 5 seconds after pressing the [F] key.

● **Numeric keys:** [1], [2], [3], [4], [5], [6], [7], [8], [9], [0]

These keys are used to select the desired operating frequency and/or memory channel number.

Memory channel 1, 8, and 9 also serve additional functions as described below.

M. channel 1 is used to store the Priority Alert channel information.

M. channel 8 is used to store the lower, and M. channel 9 the upper limit frequency for the programmable band scan.

8

● **UP/DOWN keys:** [▲], [▼]  
These keys are used to increase or decrease the operating frequency, offset frequency, tone frequency, or the power saver circuit rate.

● **F: Function exchange key**

The [F] key is used to activate the 2nd function.

The F Indicator is displayed for approx. 5 seconds after pressing the [F] key.

**CAUTION:** Press the 2nd function while F Indicator is lit.

● **M: Memory key**

The [M] key is used to select a memory channel for data entry.

The M Indicator is displayed for approx. 5 seconds after pressing the [M] key.

**CAUTION:**

Select the memory channel within 5 seconds of pressing the [M] key.

● **ENTER key**

The [ENTER] key is used to enter a frequency selected by the numeric keys.

● **SCAN key**

The [SCAN] key is used to start or stop the scan function.

● **PRIORITY CHANNEL CHECK key:** [F] + 1/PRIO

These keys are used to monitor whether the priority channel (CH 1) is busy or not. When this function is activated, the radio will switch to CH 1 approximately once every 10 seconds.

To cancel this function, press these keys again.

● **BEEP key:** [F] + 2/BEEP

Each time these keys are pressed, the audio annunciator will be turned ON or OFF.

● **(FREQUENCY) STEP key:** [F] + 3/STEP

Each time these keys are pressed, the frequency scanning step size will be increased 5 kHz.

Several different scan function keys are provided.

● **BAND SCAN key:** [F] + 4/BAND

● **MEMORY SCAN key:** [F] + 5/MEMORY

● **PROGRAMMABLE BAND SCAN key:** [F] + 6/PROGRAM

Several different scan stop keys are provided.

● **SEEK OPERATED SCAN key:** [F] + 7/SEEK

● **TIME OPERATED SCAN key:** [F] + 8/TIME

● **CARRIER OPERATED SCAN key:** [F] + 9/CARRIER

● **TX STOP key:** [F] + M/TX STOP

Pressing these keys will prevent accidental transmission. To cancel this function, press these keys again.

● **KEY LOCK key:** [F] + ENTER/KEY LOCK

Depress these keys and the frequency and other settings will remain unchanged by keyboard operation except the LAMP key.

To cancel this function, press these keys again.

● **FAST [V] key:** [F] + V/FAST

● **FAST [A] key:** [F] + A/FAST

# OPERATION

## RECEIVE

After power and antenna connections has been completed, set the switches as follows:

1. Turn the VOL control clockwise to turn on power. The frequency on the LCD display will show the transceiver is operating.
2. As the VOL control is turned clockwise, either background noise or a QSO will be heard.
3. To eliminate the no-signal noise turn the SQL control clockwise.
4. Enter the desired frequency.

## TRANSMIT

**Precaution:** Check the intended transmit frequency before operating to prevent interference with other stations.

1. Simply depress the PTT switch and the [ON/AIR] indicator will light.
2. Speak into the microphone. Recommended talk distance to the microphone is approximately 2 inches (5 cm).



### CAUTION:

Long transmission or extended operation in the S watt mode might cause the rear of the transceiver to get warm. Do not place the transceiver where the heat sink (rear panel) might come in contact with plastic or vinyl surfaces.

## FREQUENCY SELECTIONS

Two different methods are provided for frequency selection.

### UP/DOWN key frequency selection

- 1 Pressing either the  or the  key momentarily will cause the displayed frequency to change 1 step up or down, respectively. The step size is selected by pressing the [F] and the 3/STEP key from 5 step sizes (5, 10, 15, 20, 25 kHz).



- 2 Pressing the  or the  key for more than 1 second will cause to change up or down continuously until the key is released.

- 3 Pressing the [F] and holding the  or the  key will cause to change quite rapidly.



Repeating this operation shifts the displayed frequency as shown below.

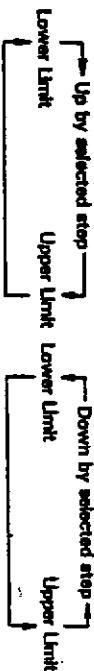

### ● Direct keyboard frequency entry

Press the **ENTER** key.

U.S.A. version

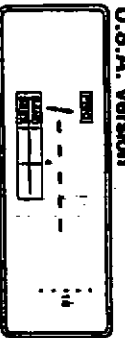

Other version

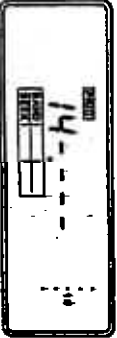

Enter all digits frequency.

For example

U.S.A. version

1, 4, 5, 6, 0

Other version

14, 5, 6, 0



In the 1 kHz digit, 10 numeric keys becomes as shown below.

Key	0,1,2,3,4	5,6,7,8,9
1 kHz digit	0	5

The receiver will not change frequency until all digits have been entered.

If you should make an error before entering all digits, press the **ENTER** key twice, and reenter all digits.

### ■ BEEP TONE

Audible confirmation of microprocessor function is provided in the form of a series of audio beeps.

To activate beep tones, press the **F** key and 2/BEEP key.

The radio will then supply audio confirmation according to the chart below.

Scale	Frequency (Hz)	Key operation
A	440.00	MN 0
A'	460.16	MN 1
B	483.98	MN 2
C	523.28	MN 3, SAVE ON
C'	554.37	MN 4, OFFSET
D	587.33	MN 5, To select OFFSET Frequency.
D'	622.26	MN 6, REV, To select Tone Frequency
E	658.48	MN 7, TUNSTOP, SAVE AUTO
F	698.48	MN 8, To change the rate of Power Save time, ENTER
F'	738.98	MN 8, KEYLOCK
G	783.98	DOWN, SAVE OFF
G'	830.61	UP
A	890.00	F
A'	892.38	M
B	987.27	Scanning starting
F	1389.91	Key operation without effect.

## ■ REPEATER OPERATION

### ● Transmitter offsets

All amateur radio repeater utilize a separate receiver and transmitter section. The receiver frequency may be either above or below the transmitter frequency. The transceiver allows you to store the frequency and offset in memory, or you can select the offset and offset frequency from the keyboard.

To select the desired offset, press the OFFSET/F key. Each time you press the key the radio will advance from one offset to the other, i.e. "+" to "-" to no offset or simplex.

To select the desired offset frequency, press the [F] and the OFFSET/F key. The display shows present transmitt offset.

Press either the [▲] key or the [▼] key momentarily, the frequency change 100 kHz step up or down from lower limit 100 kHz to upper limit 9.9 MHz. Press the [ENTER] key to complete the selection.

### ● Reverse function

The R/TONE. F key has been provided to allow you to reverse the transmit and receive frequencies.

To use the REVERSE function, press the R/TONE. F (or REVERSE) key. The R Indicator will light in the display.

To return to normal offsets press the R/TONE. F (or REVERSE) key again (with the TH-415A/215A). This function is useful to check the input frequency of the repeater so that you can determine if you are within SIMPLEX range.

### ● Tone operations

Some repeaters require the use of a control signal to activate the repeater. Several versions are currently in use worldwide.

TH-415A/215A:

The transceiver provides a subaudible tone encoder with 38 standard tone frequencies. To activate the appropriate tone signaling device, depress the TONE switch on the top of the radio.

The decoder section is an optional accessory (TSU-4). That allows for T.SQ (Tone Squelch) operation. With this option you will only hear those stations that transmit the same subaudible tone directly.

TH-415E/215E:

In Europe a 1750 Hz tone is used in transmit. In the United Kingdom a 1750 Hz tone burst at the beginning of each transmission is used. Since use of these tones is required in the U.K. and in Europe the tone encoder is included as standard equipment.

To select the tone frequency, press the **F** and the **R/TONE.F** key. The display will show a operating tone frequency.

Press either the **▲** key or the **▼** key momentarily, the frequency will change 1 step up or down. Press the **ENTER** key to complete the selection.

Tone Frequency	
67.0 Hz	107.2 Hz
71.9 Hz	110.8 Hz
74.4 Hz	114.8 Hz
77.0 Hz	118.8 Hz
79.7 Hz	123.0 Hz
82.5 Hz	127.3 Hz
85.4 Hz	131.6 Hz
88.5 Hz	136.5 Hz
91.6 Hz	141.3 Hz
94.8 Hz	146.2 Hz
97.4 Hz	151.4 Hz
100.0 Hz	156.7 Hz
103.5 Hz	162.2 Hz

To activate the tone squelch function (decode), turn the Squelch control fully counterclockwise past the detent. Squelch will now open only when the radio receives the same subtone frequency. To return to normal noise activated squelch, turn the Squelch control clockwise past the detent.

It is a good operating practice to check the frequency before transmitting. A MONITOR switch has been provided for this purpose when using the TONE SQUELCH function. Pressing this switch will open the squelch so you can check for activity.

**NOTE:** 97.4 Hz is available only to encode.

● **Autopatch operations (with the TH-415A/215A)**

Some repeaters offer a service known as AUTOPATCH. This allows you to dial a telephone number from your radio and carry out a telephone conversation, much like a car telephone, or cellular telephone. This function requires the use of a DTMF (Dual Tone Multi Frequency) pad. This is also known as a touch tone pad. It operates just like the touch tone pad on your home telephone. In addition to the normal 12 keys that are found on your telephone the transceiver also provides 4 additional keys A, B, C, and D. These keys are required by some repeater systems for various control functions. You should check with the control operator of your repeater to determine if their use is required. A chart is provided that lists the tones that are generated when you press each key.

To use the touch tone pad you should first key the radio using the PTT switch. Then simply press the numbers corresponding to the telephone number you want to dial. Some repeaters will require a special sequence of keys to activate the autopatch. Again you should check with the control operator of your repeater for this sequence.

After you have pressed the first number key the radio will remain keyed for approximately 2 seconds. This is done so you do not have to hold the PTT switch depressed while dialing. The radio remains keyed after you press each number for this 2 seconds interval.

Callm Row	1208	1336	1477	1633
697	1	2	3	F-A
770	4	5	6	M-B
852	7	8	9	BUTTER C
941	▲	0	▼	SCAN =0

## ■ SCAN

Scan is initiated by pressing the **[SCAN]** key. The transceiver will stop on a busy channel. When an incoming signal is detected during scanning, the BUSY indicator will light. In order for this function to operate the SQL control must be adjusted to the threshold point. Scan direction can be selected by either the **[▲]** or the **[▼]** key before initiating scan. The selected scan mode and scan stop mode indicators will flash ON and OFF during scanning.

### ● SCAN MODES

1. **BAND SCAN MODE:** Scans the entire band.
2. **MEMORY SCAN MODE:** Scans the memory channels repeatedly, skipping the vacant channels.
3. **PROGRAMMABLE BAND SCAN MODE:** Scans between the frequencies stored in memory channels 8 and 9. If the frequency stored in memory channel 8 is the same or greater than in memory 9, or if either or both channels are vacant, scan will proceed over the entire band.

If SCAN is initiated while the displayed frequency is outside the range specified in memory channels 8 and 9, scan will proceed outside of the programmed limits. In the BAND SCAN and PROGRAMMABLE BAND SCAN MODE, scan proceeds according to the selected step size.

### ● SCAN STOP AND RESUME MODES

1. **SEEK OPERATED SCAN:** Scan will stop on a busy channel and will be released when a signal is present and squelch is open.
2. **TIME OPERATED SCAN:** Scan will stop on a busy channel and resume approx. 5 seconds afterwards. Scan will resume even if the station is still present.
3. **CARRIER OPERATED SCAN:** Scan will hold as long as the signal is present and resume scan after a 2 second delay if the signal drops out.

Releasing scan: Press one of the following keys during scanning to clear the scan mode.

- a) **[SCAN]** key
- b) **[PTT]** switch

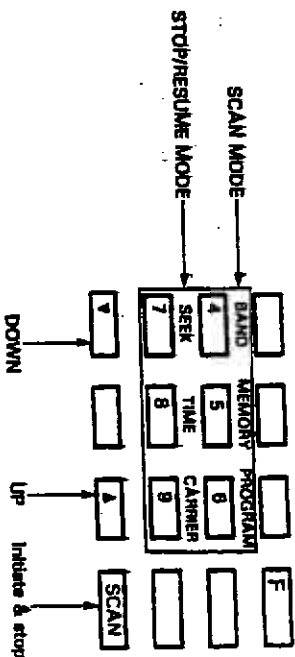

## ■ MEMORY

### ● MEMORY CHANNELS

The 10 memory channels (1 through 9, and 0) are available for data entry. Channel 1, 8 and 9 have the following functions in addition to its ordinary function.

Channel 1 is the Priority Alert Channel.

Channel 8 is the lower, and channel 9 is the upper limit frequency for the programmable band scan operation.

Each memory channel can store RX Frequency, F. STEP status, OFFSET, REVERSE switch status (TH-415A/215A), and TONE Frequency (TH-415A/215A).

### ● MEMORY ENTRY

1. Press the **[M]** key. The display will indicate M and any memory channels that contain data. (Ex. 1, 4, 7, 8, 9)
2. Press the desired memory channel number (Ex. 5) within 5 seconds of pressing the **[M]** key. This will actually store the information into memory.

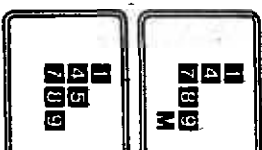

### ● MEMORY RECALL

Simply press the desired memory channel key and the radio will switch to this frequency. To return to the original operating frequency, press the same memory channel key again.

### ● CLEARING A SPECIFIC MEMORY CHANNEL

1. Press the **[M]** key. The display will indicate M and any memory channels that contain data. (Ex. 1, 4, 5, 7, 8, 9)
2. Press the **[F]** key. The F indicator will illuminate.
3. Press the desired channel number to clear (Ex. 7) within 5 seconds of pressing the **[F]** key. The M, F, and channel number display will clear indicating the operation has been completed.
4. To confirm the data was erased press the **[M]** key. (From our example the 7 will now be gone.)

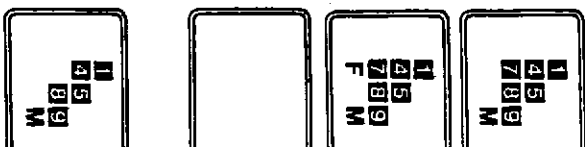

### ● CLEARING ALL MEMORY

(= Microprocessor Initialization)

To erase all data from the memory, turn the power switch on while pressing both the **[F]** and the **[ENTER]** keys.

## ● MEMORY BACK-UP BATTERY

The transceiver includes a lithium back-up battery to retain memory in the microprocessor. When charging batteries, or if the Ni-Cd batteries should fully discharge, memory will always be retained.

If the display should begin to show erroneous information or numbers, the lithium battery needs replacement.

This should be performed by an authorized KENWOOD dealer since these components are easily damaged by static electricity.

## ■ PRIORITY ALERT CHANNEL CHECK

Memory channel 1 can be monitored at about 5 seconds intervals to check for activity.

Press the [F] key and then the 1/PRIO key. [PRIO] will appear on the display.

If the channel is busy, the [PRIO] blinks, and if the BEEP function is ON, a beep will sound.

Memory channel 1

Not used..... [PRIO] ..... displaying

Busy..... [PRIO] ..... blinking

To stop the function, press these keys again.

The function does not operated during scan and transmission.

## ■ BATTERY SAVER

Battery Saver operation provides to turn ON or OFF battery power automatically during reception and thus extend operation time.

### 2 ACTIVATION MODES

1. **SAVE MODE:** Activates the battery saver circuit 2 seconds after the squelch closes.
2. **AUTO SAVE MODE:** Activates the battery saver circuit 1 minute after the last key operation during the squelch closes.

To select the desired Battery Saver Mode, press the [SAVE] key. Each time press the key, radio will advance from SAVE to AUTO SAVE to OFF. The indicator will light;

SAVE MODE : [SAVE]  
AUTO SAVE MODE : [AUTO/SAVE]  
OFF : No indicator

To alter the actual length of time the receiver section shuts down, press the [F] key and then the [SAVE] key. The display will show the time the radio will be operating at reduced power levels.

The radio will operate at reduced power consumption according to the accompanying diagram.

For example:

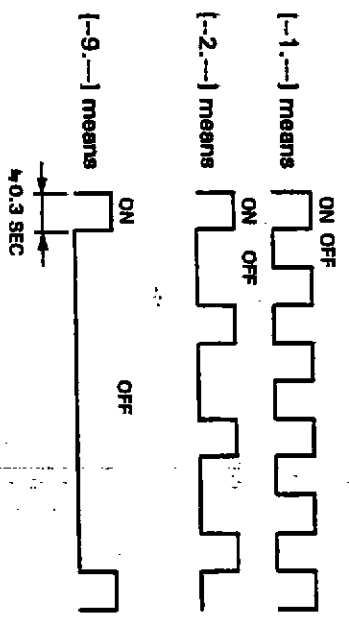

When a signal is received, the function is automatically released.  
As the receiver section shuts down, the squelch is not opened by pressing the MONITOR switch. (It is Approx. 2 seconds in the ratio 1 : 9.)

# MAINTENANCE

## ■ IN CASE OF DIFFICULTY

**WHEN USING SUN-3/AA BATTERIES, ENSURE THE BATTERY POLARITY AND VOLTAGE IS CORRECT BEFORE PROCEEDING. No sound from the speaker. No signal can be received.**

1. Squelch is closed. Turn the SOL control counterclockwise.
2. T.SQ is activated. Turn the SOL control clockwise past the detent position.
3. PTT switch of microphone is pressed setting the unit in the transmit mode. Turn PTT switch off.

**No control works.**

**KEY LOCK is ON.** Press **[E]** key and **KEY LOCK** key.

**No output**

1. Microphone jack is not fully plugged in. Insert the plug fully.
  2. Poor antenna connection. Connect antenna securely. Memory loss. Backup battery voltage is low. Contact the authorized dealer.
- All the indicators go out on the display.**  
Turn the power switch OFF and then ON.

## ■ SERVICE

Should it ever become necessary to return the equipment to your dealer or service center for repair, pack in its original box and packing, and include a full description of the problems involved. Also include your telephone number. You need not return accessory items unless directly related to the service problem.

**Service note:** Dear OM, if you desire to correspond on a technical or operational problem, please make your note short, complete, and to the point. And PLEASE make it readable. Please list: Model and serial number. The question or problem you are having. When claiming warranty service, a photocopy of the bill of sale, or other proof of purchase showing the date of sale must accompany the radio.

OPTION	
SWIVEL MOUNT <b>BH-6</b>	MICRO HEADPHONES <b>HS-7</b>
TELESCOPING ANTENNA <b>RA-3 (144 MHz)</b>	MICRO HEADPHONE <b>HS-8</b>
SOFT CASE <b>SC-13</b> (for Pb-1/1A)	MOBILE MOUNTING BRACKET <b>MB-4</b>
PROGRAMMABLE TONE DECODER UNIT <b>TSU-4</b>	FILTERED CIGAR LIGHTER CORD <b>PG-3C</b>
SOFT CASE <b>SC-12</b> (for Pb-2/3)	DC CABLE <b>PG-2V</b>
POWER SUPPLY	
Ni-Cd RECHARGEABLE BATTERY PACK <b>PB-1</b> 12V 800mAh	Ni-Cd RECHARGEABLE BATTERY PACK <b>PB-3</b> 7.2V 800mAh
Ni-Cd RECHARGEABLE BATTERY PACK <b>PB-2</b> 8.4V 800mAh	Ni-Cd RECHARGEABLE BATTERY PACK <b>PB-4</b> 7.2V 1800mAh
RAPID CHARGER <b>BC-7</b> (for Pb-1/2/3/4)	COMPACT CHARGER <b>BC-8</b> (for Pb-1/2/3/4)
	AA (MANAGANISE)/ ALKALINE BATTERY CASE <b>BT-5</b>
	BATTERY CHARGER <b>BC-2</b> (for Pb-3 only)

**NOTE:** Some optional accessories may not be available in your areas. Some cars may not be suitable to hook the MB-4 into the window. HMC-1 vox headset cannot be used.

## PROGRAMMABLE TONE DECODER UNIT (TSU-4) INSTALLATION

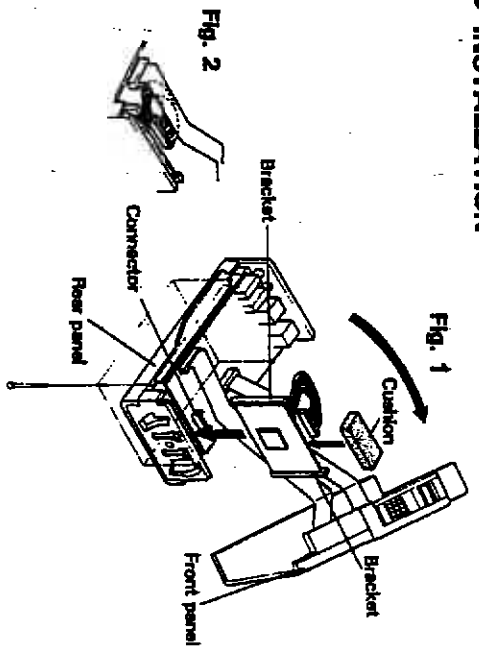

1. Remove the four Phillips head screws from the rear panel of the radio.
2. Gently remove the front panel. The panel should be rotated away from the PTT switch side.
3. Remove the foam cushion attaching the bottom of the set. Install the tone squelch Unit between the bottom of the set and the main circuit board as Fig. 1.
4. Attach the cable from the TSU-4 as Fig. 2. The cable should be routed under the ribbon cable that goes to the front panel.
5. Remove the backing from the foam cushion that was provided with the TSU-4 and attach the cushion to the edge of the TSU-4.
6. Reverse 1.

KENWOOD

